

WE67K-SMART CNC Electro-hydraulic Press Brake

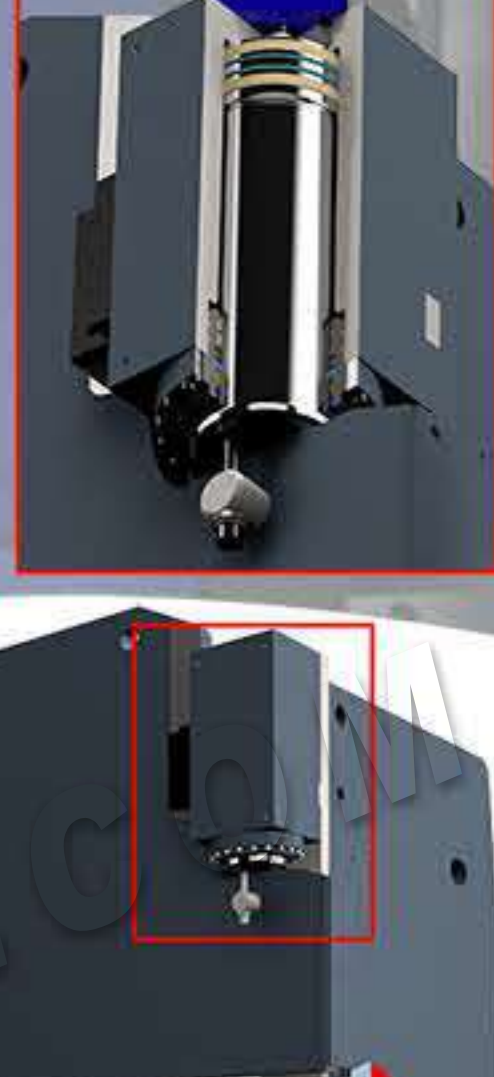

RIGID FRAME CONSTRUCTION & DUAL HYDRAULIC CYLINDERS

The foundation of every HARSLE press brake is a solid, mono-block frame made from mill certified, high-yield steel. As a result our press brakes perform accurately and reliably year after year. We're so confident in our frames that we offer a 10-year warranty with our standard machines.

Dual hydraulic cylinders located on either side of the ram provide faster approach speeds. The cylinders are synchronized to provide smooth motion resulting in precise ram positions to accuracies of .0004"

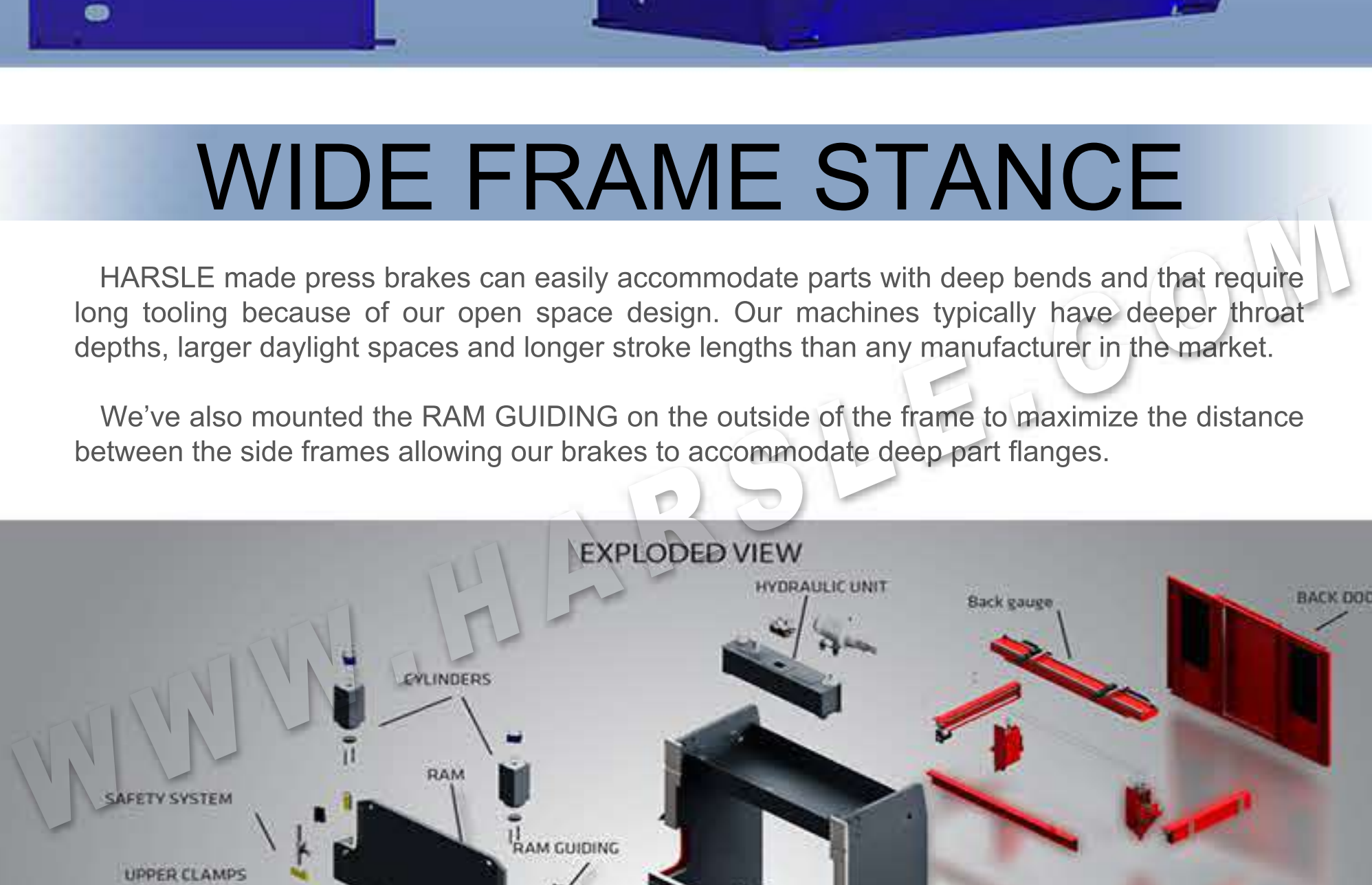
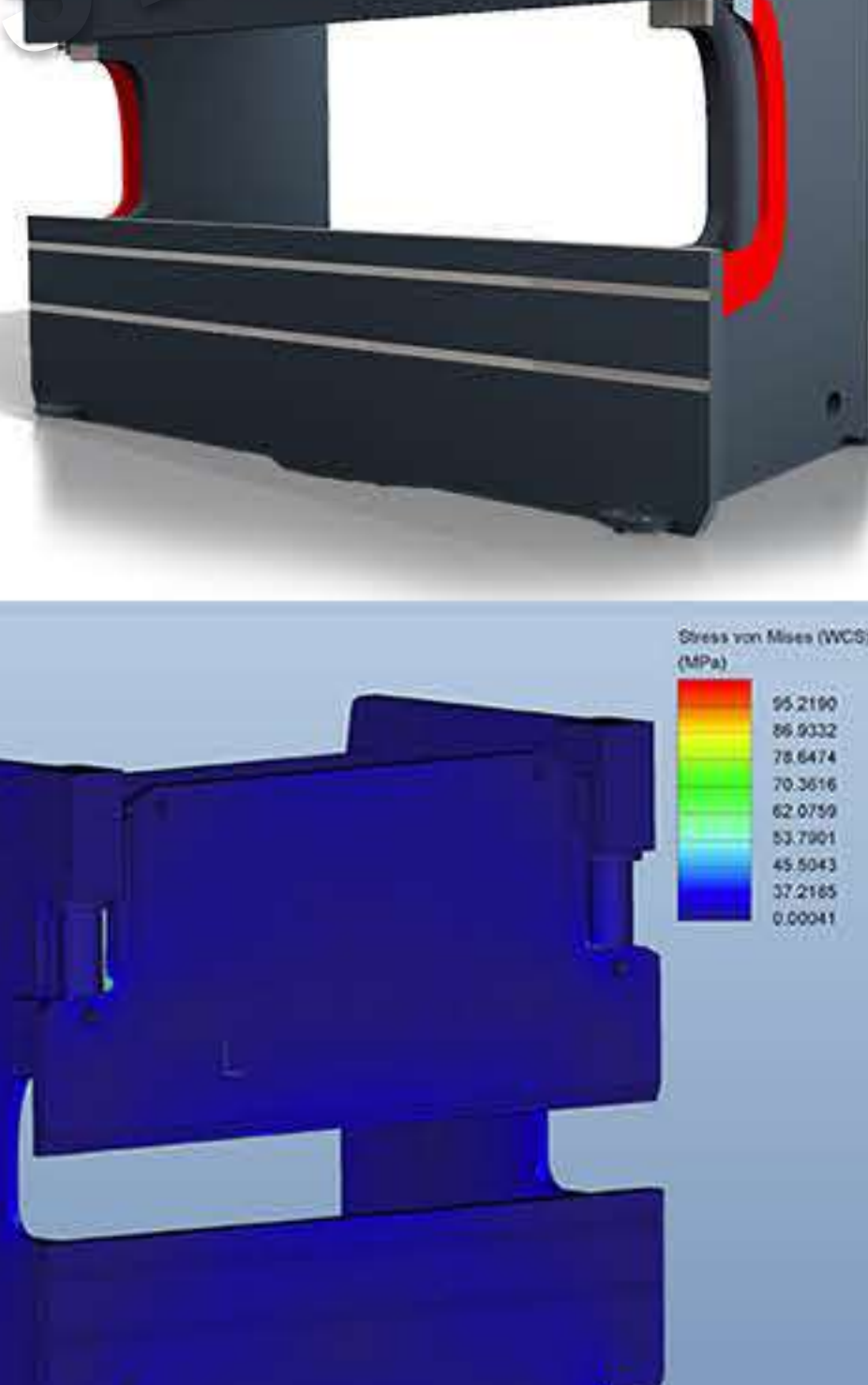

WIDE FRAME STANCE

HARSLE made press brakes can easily accommodate parts with deep bends and that require long tooling because of our open space design. Our machines typically have deeper throat depths, larger daylight spaces and longer stroke lengths than any manufacturer in the market.

We've also mounted the RAM GUIDING on the outside of the frame to maximize the distance between the side frames allowing our brakes to accommodate deep part flanges.

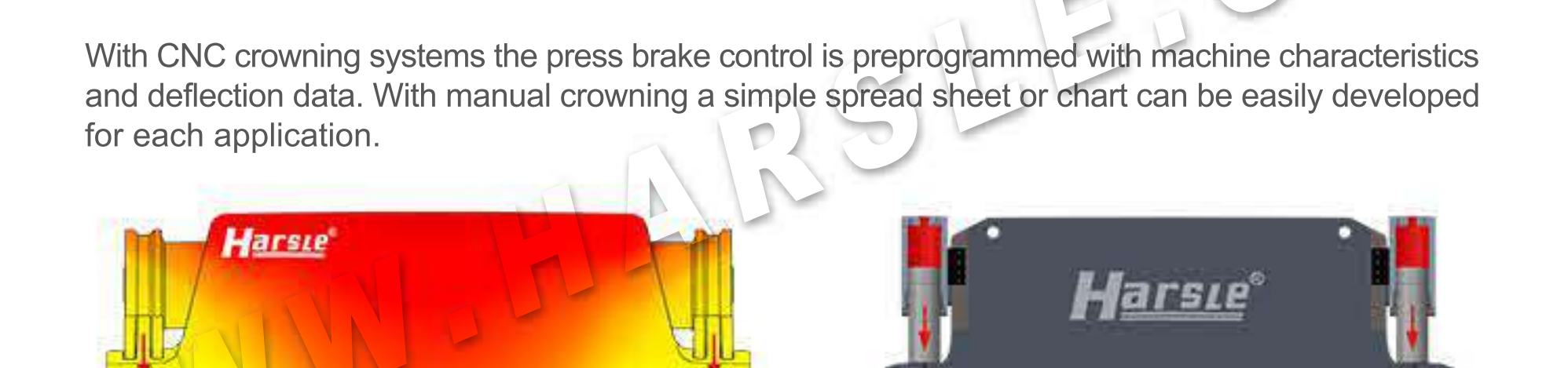

CROWNING SYSTEMS

Manual and CNC crowning ensures a constant bend angle across the full length of the machine. This is achieved by pre loading the machine, to offset any possible deflection under load or compensate for any tool wear, so that under load contacting surfaces are parallel to each other.

With CNC crowning systems the press brake control is preprogrammed with machine characteristics and deflection data. With manual crowning a simple spread sheet or chart can be easily developed for each application.

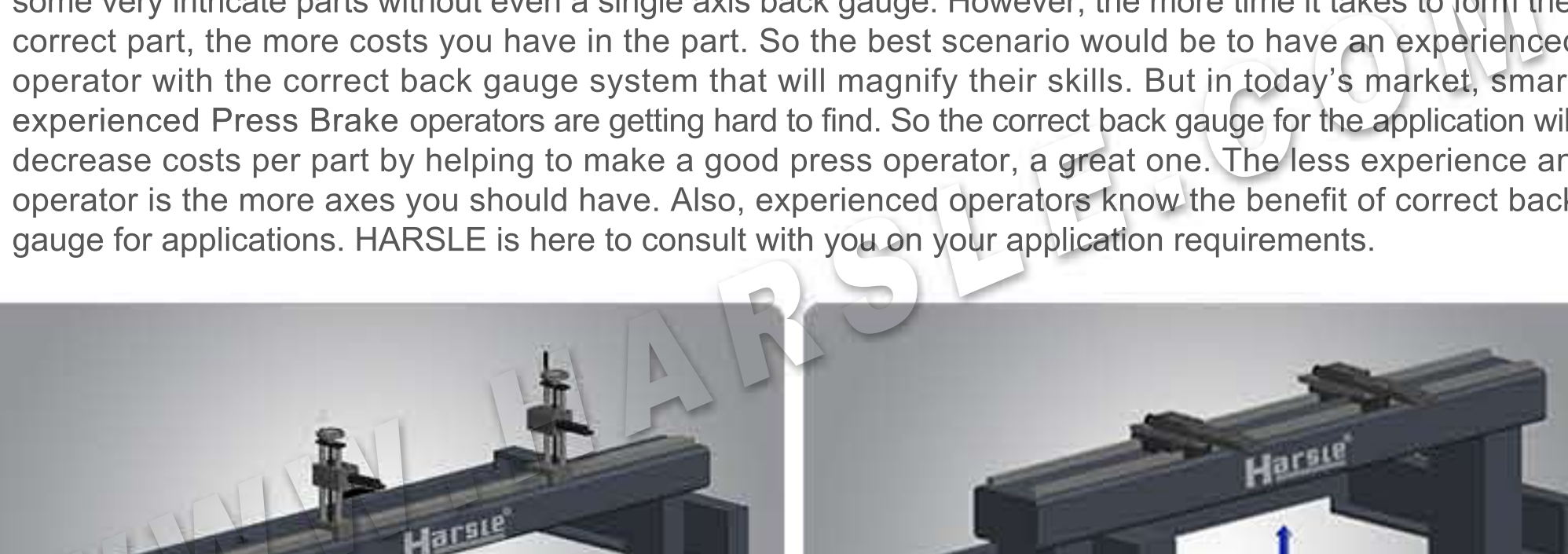
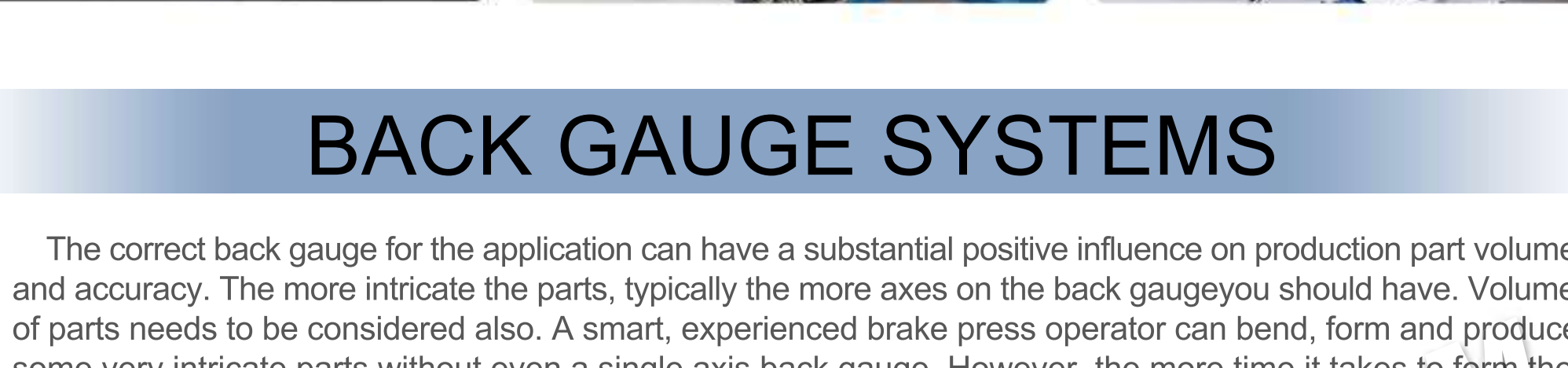
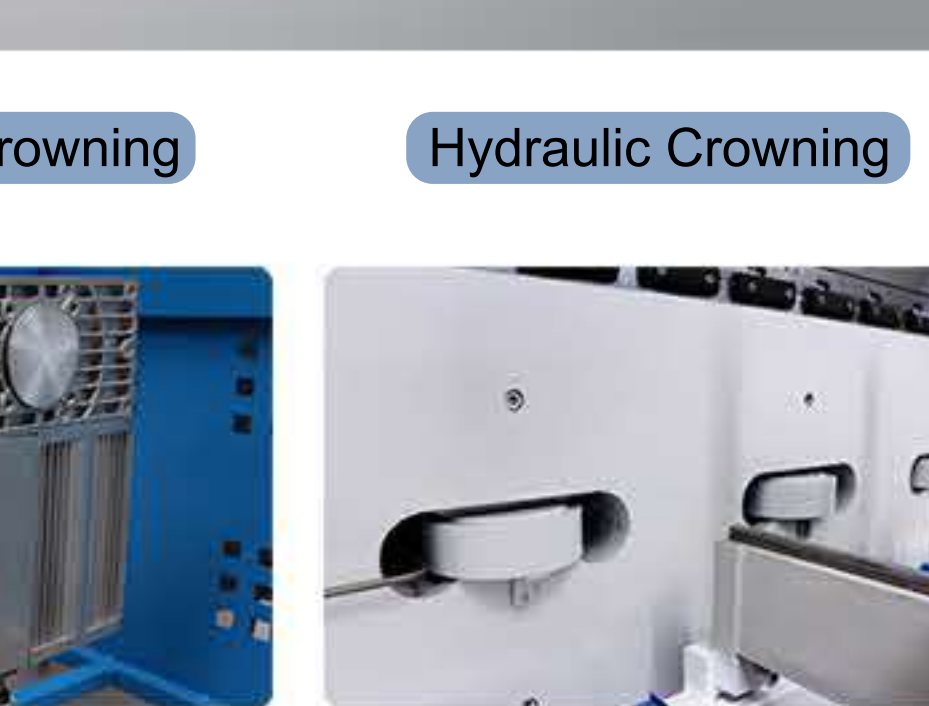
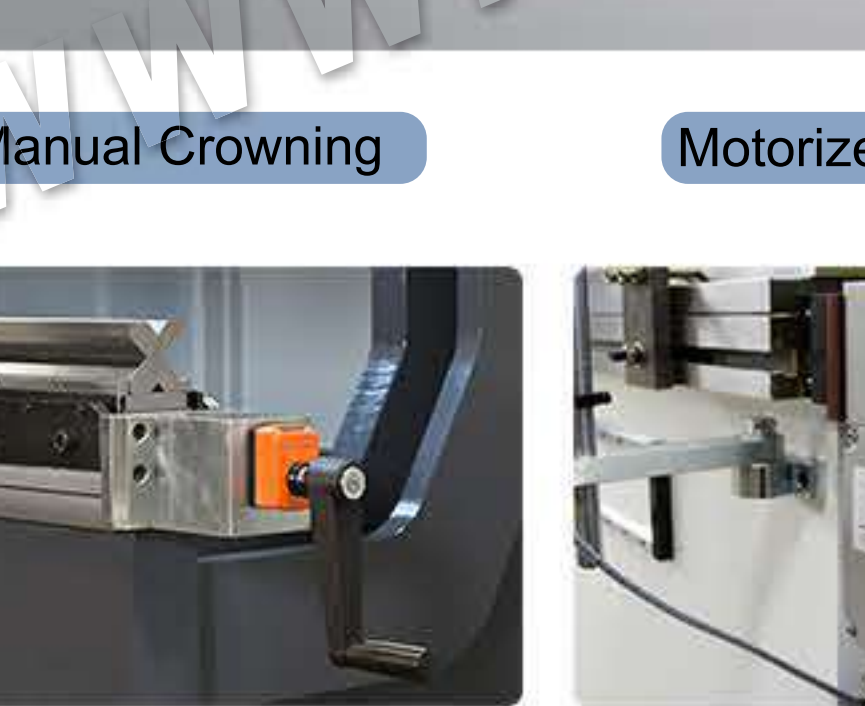
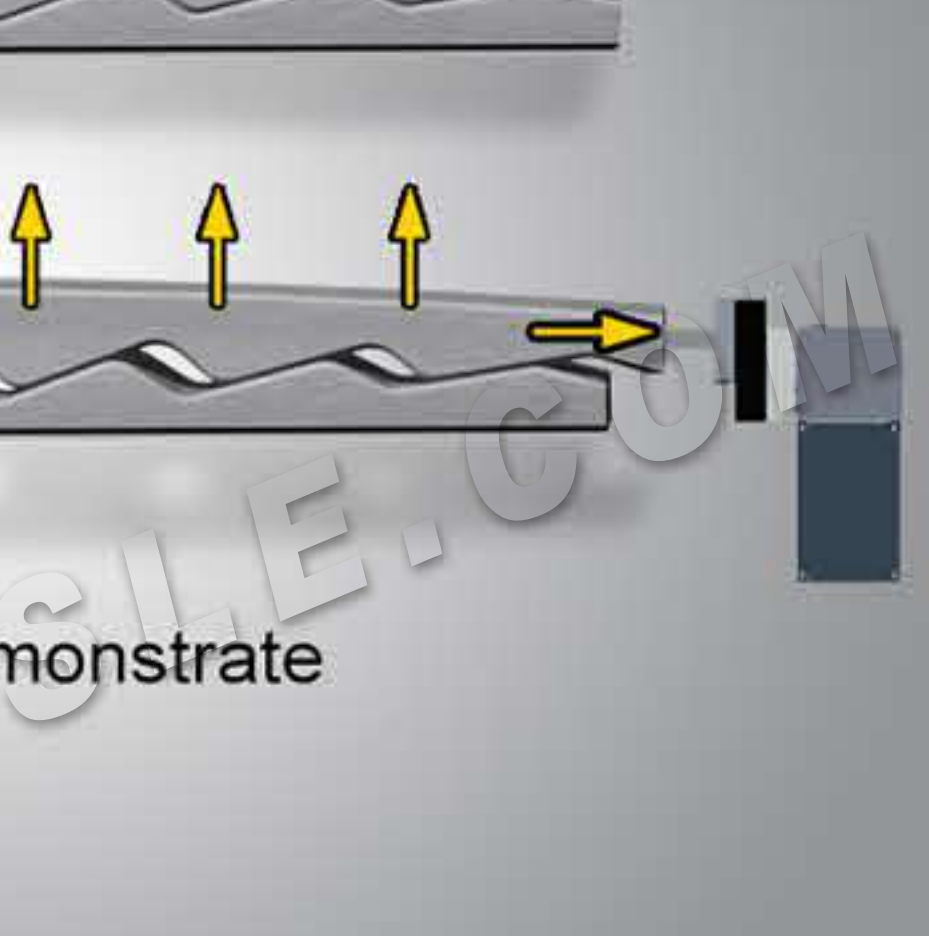
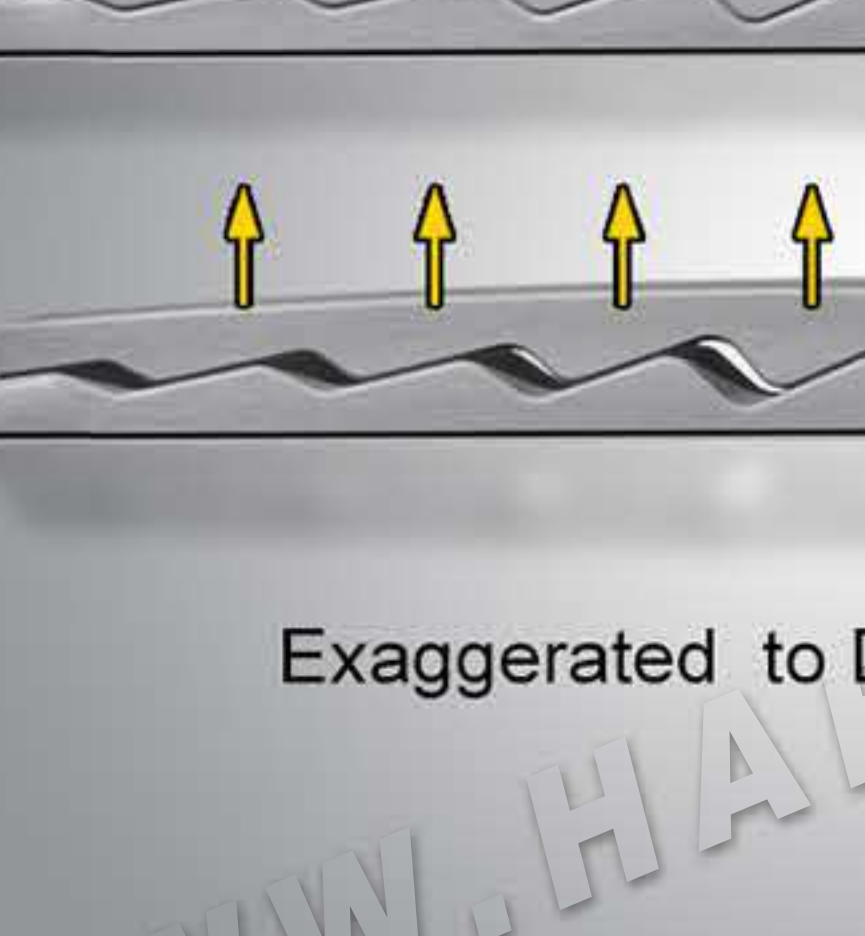

BACK GAUGE SYSTEMS

The correct back gauge for the parts can have a major positive influence on production part volume and accuracy. The more intricate the parts, typically the more axes on the back gauge you should have. Volume of parts needs to be considered also. A smart, experienced brake press operator can bend, form and produce some very intricate parts without even a single axis back gauge. However, the more time it takes to form the correct part, the more costs you have in the part. So the best scenario would be to have an experienced operator with the correct back gauge system that will magnify their skills. But in today's market, smart, experienced Press Brake operators are getting hard to find. So the correct back gauge for the application will decrease costs per part by helping to make a good press operator, a great one. The less experience an operator is the more axes you should have. Also, experienced operators know the benefit of correct back gauge for applications. HARSLE is here to consult with you on your application requirements.



1 AXIS BACK GAUGE (X)

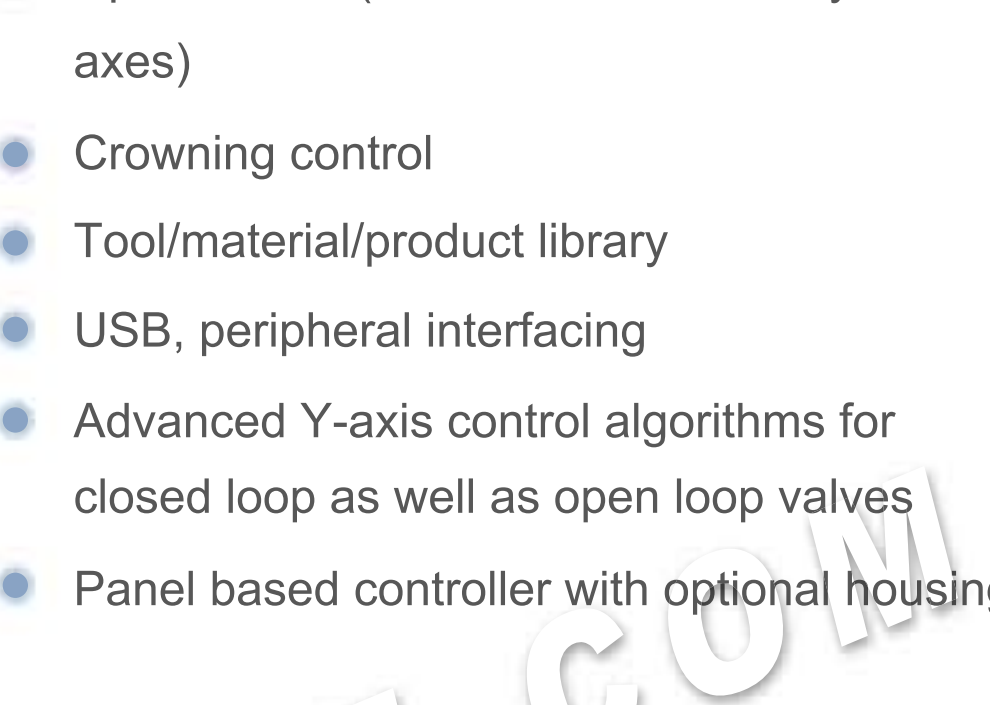

2 AXIS BACK GAUGE (X,R)

STANDARD CONFIGURATION

DA-52S Feature

- Quick, one page programming
- Hotkey navigation
- 7" widescreen colour TFT
- Up to 4 axes (Y1, Y2, and 2 auxiliary axes)
- Crowning control
- Tool/material/product library
- USB, peripheral interfacing
- Advanced Y-axis control algorithms for closed loop as well as open loop valves
- Panel based controller with optional housing

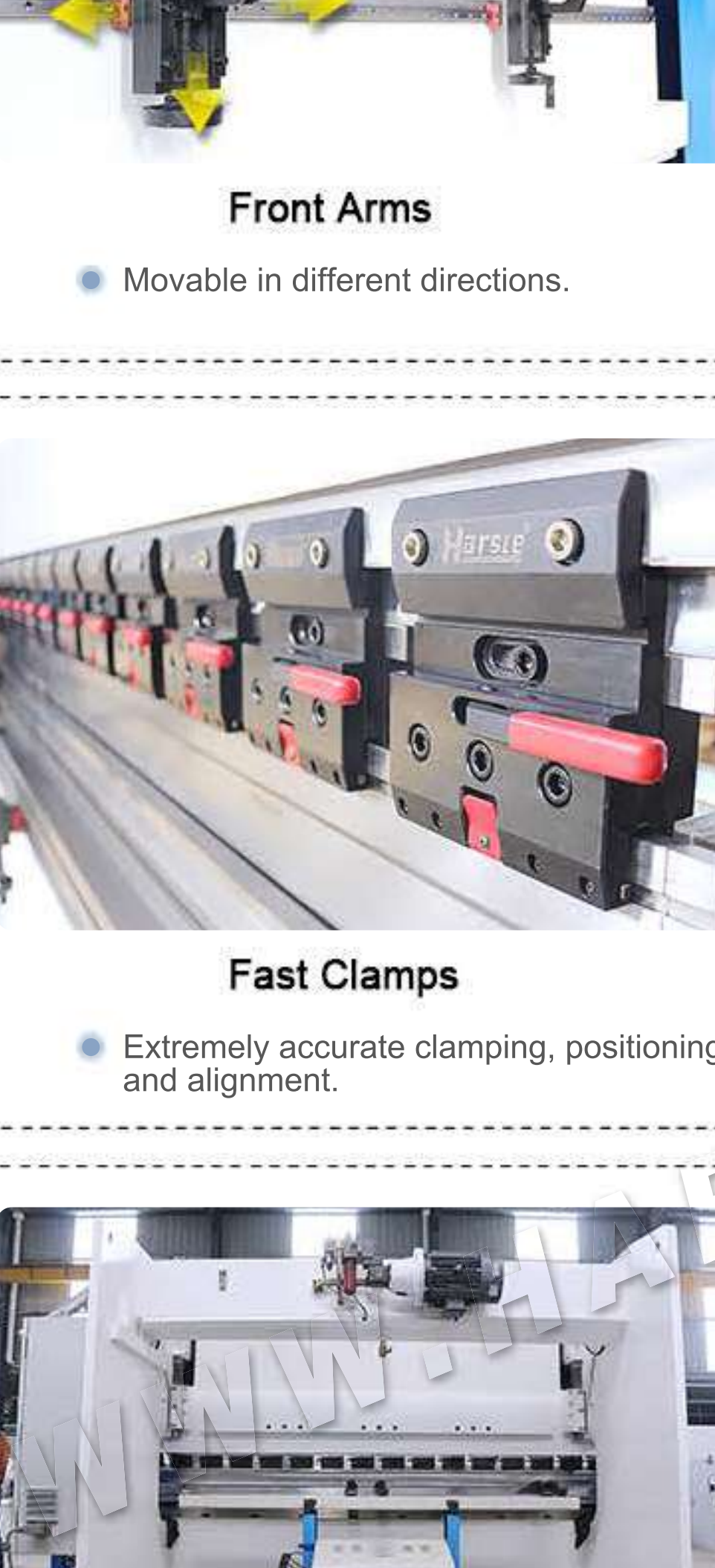

PRODUCT DETAILS



Front Arms

- Movable in different directions.



Segmented Bending Toolings

- Extremely fast press brake tooling changes.

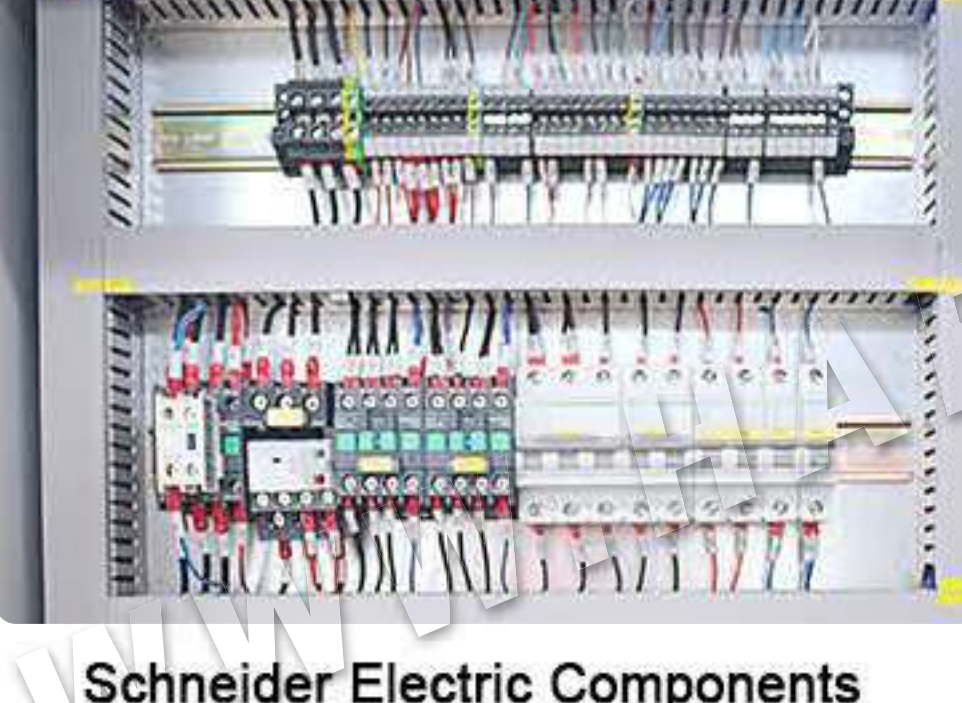

Fast Clamps

- Extremely accurate clamping, positioning and alignment.



KACON Foot Switch

- South Korea brand foot switch ismovable and can stop the machineanytime by the emergency button.



Safety Fence

- Protective guards on each side can protect the user during operation.

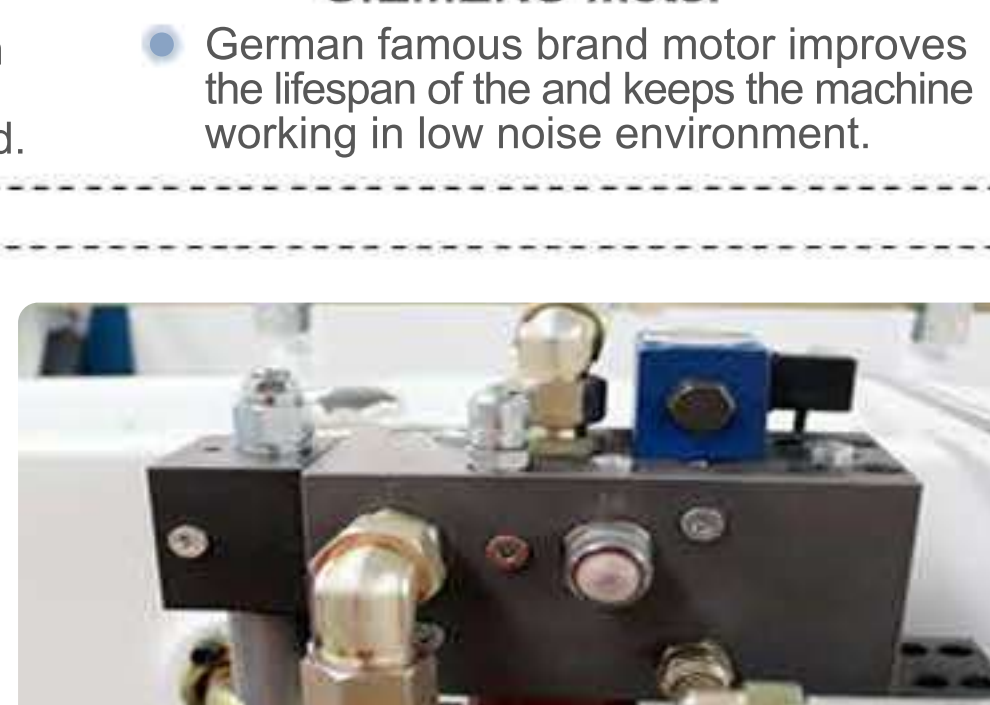

Ball Screw and Linear Guide

- HIWIN From Taiwan.

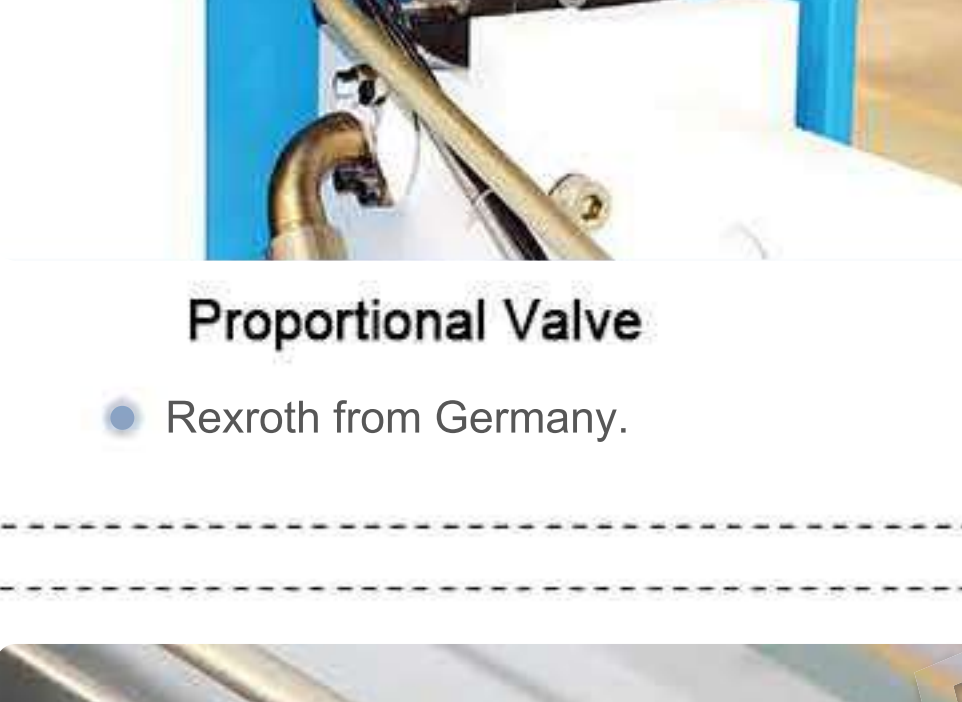

Servo Motor

- World famous brand YASKAWA, working fastly with high accuracy.



Linear Encoder

- Spanish FAGOR can get high performance.



Schneider Electric Components

- High quality electric parts can perform well even the electricity is not stable and customers can easily get the replacement anywhere in the world.



SIEMENS Motor

- German famous brand motor improves the lifespan of the and keeps the machine working in low noise environment.



Proportional Valve

- Rexroth from Germany.



Hydraulic Valve

- Rexroth from Germany.



EMB Tubing connector

- Good-looking structure and reduce the possibility of oil leakage.



Z Stopper

- Fine adjustment with high accuracy up to ±0.02mm.

OPTIONAL CONFIGURATION



Special Punch and Die



Hydraulic clamping System

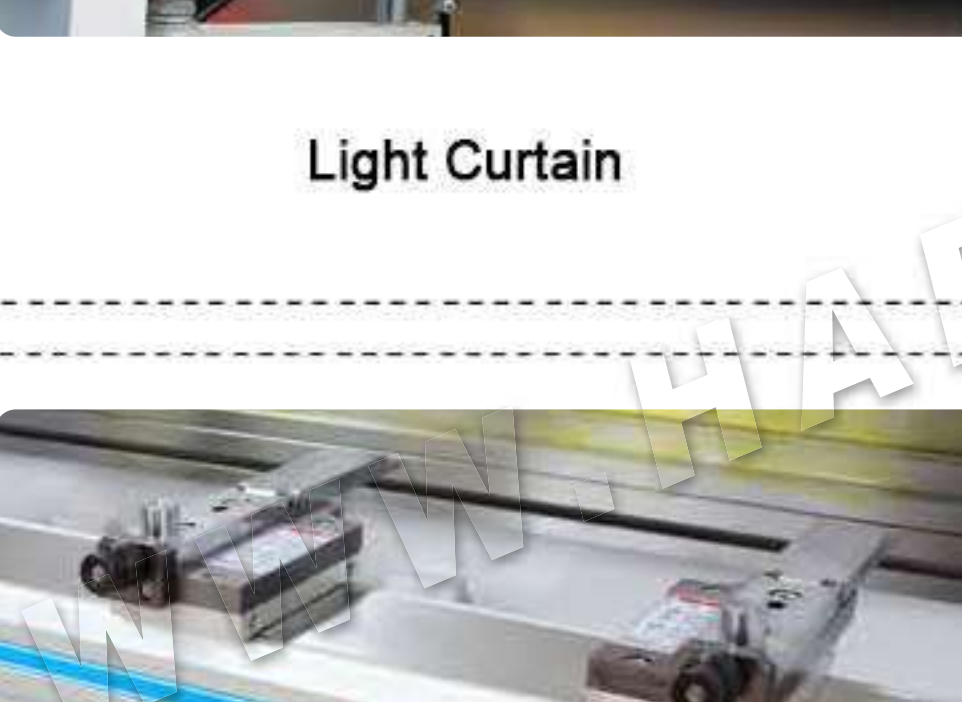

AMADA Type Fast Clamp



KYOKKO Type Fast Clamp



Light Curtain



Laser protector

Motorized Movable Z Stopper

Adjustable Z Stopper